



# SonTek-IQ™ Series Standard, Plus and Pipe

FLOW, TOTAL VOLUME, LEVEL AND VELOCITY



a xylem brand



## Built to Last. Made to Perform.

Developed with assistance from the Cooperative State Research, Education, and Extension Service of the U.S. Department of Agriculture, the SonTek-IQ Series are three products that provide high quality flow, total volume, level and velocity data for challenging conditions that fit your budget. Custom flow algorithms, carefully designed and tested, ensure all these products in the Series will deliver the data you need to make smart decisions about your water. Each system offers four independent velocity beams that can accurately map the cross-section velocity, both in the center and out towards each edge. High-resolution profile data combined with smart and flexible programming means the IQ adeptly meets the widest variety of environments and flow conditions, from irrigation canals to wastewater collections and CSOs\*; from industrial pipes to natural streams. In many cases, very high-accuracy flow data can be instantly obtained with no velocity indexing required. Additionally, the built-in pressure sensor (standard with each system), works in tandem with the vertical acoustic beam to measure the water level, delivering the most robust stage measurements ever.

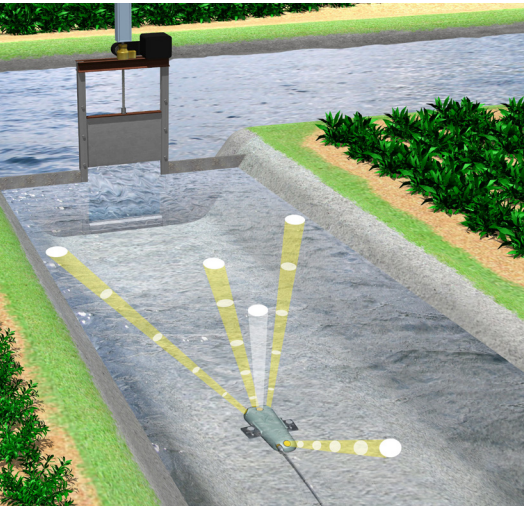

- Fully self-contained, all-in-one design
- Measure flow in man-made or natural channels, pipes or streams between 8 cm (3 inches) and 5 m (16 ft) deep
- Uses SonTek's exclusive SmartPulse<sup>HD</sup>® adaptive sampling technology under all conditions
- Four, pulsed Doppler velocity beams for great section coverage
- Specialized flow algorithms for open channels and/or closed pipes, including irregular shapes
- Handles very slow and reversing flow conditions
- Self-calibrating water level using vertical beam and pressure sensor
- RS-232, SDI-12, Modbus, Analog communication/output

\*The SonTek-IQ Series is not IS or ATEX certified. Do not use in areas with explosion risk.

Whether you need just a practical and cost-effective solution for a single canal, or you operate a large public utility with dozens of monitoring sites, there's a SonTek-IQ right for your application. Simply input the channel geometry using the intuitive SonTek-IQ software and you are outputting accurate flow data in minutes!

*The SonTek-IQ software package is the starting point for interfacing with the instrument.*

*The "SmartPage" has built-in icons that guide users through the configuration steps to collect the best possible data. Want to run some statistics on the data? You can do that too, with just one click.*

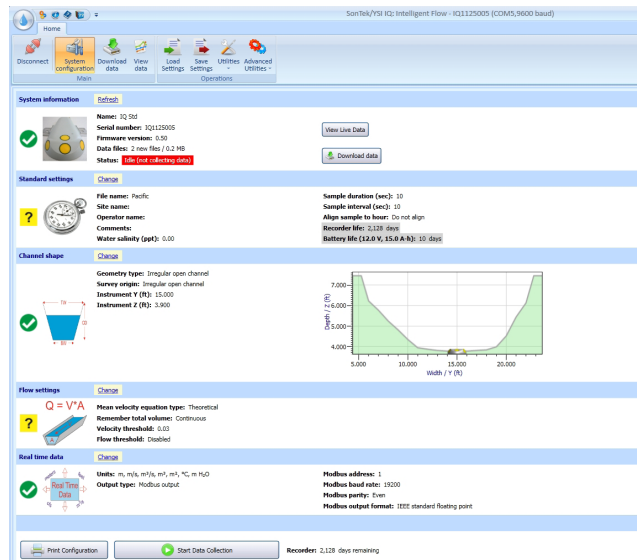



## SonTek-IQ Standard: Big Quality for Small Budgets

The SonTek-IQ Standard version is a “no frills” option for the budget-minded operator. But with the SonTek-IQ Standard, low budgets do not mean low quality data! Using the same powerful SmartPulse<sup>HD</sup> technology that is used in the SonTek-IQ Plus system, you won't be sacrificing quality while monitoring your flow.

The Standard version allows measurement for depths up to 1.5 m in open-channels only, and basic data parameters output for display or export based on a dynamic, single integrated velocity cell.

## SonTek-IQ Plus: Monitoring in Complex Environments

The SonTek-IQ Plus version offers a flow monitoring solution for larger canals and natural environments with depths up to 5 m. With the ability to collect velocity profiling data in cells as small as 2 cm across a channel horizontally and vertically, this version offers the user complete flexibility in applications and detailed flow velocity parameters for those times when “just flow” isn't enough.

The SonTek-IQ Plus is capable of handling not just regular trapezoidal canals, but any irregular/naturally-shaped channel, up to 5 m deep, where flow, velocity and/or level need to be measured. And with the flexibility of the SonTek-IQ software, the opportunities are endless.

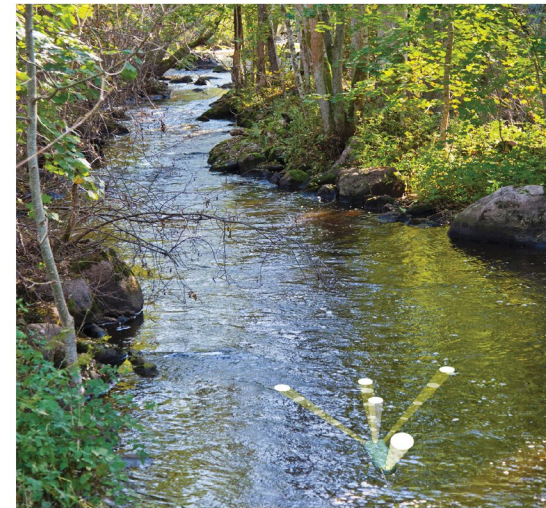

## SonTek-IQ Pipe: Accurate Flow in Totally or Partially Full Pipes

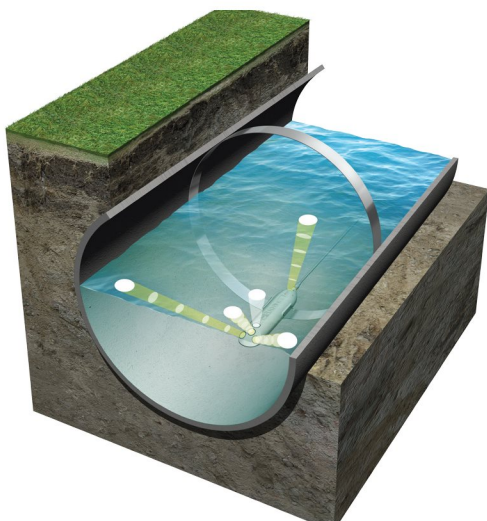

The SonTek-IQ Pipe is intended as either a bottom or top mounted flow meter that can be used in most industrial or agricultural applications. Unlike many other flow meters available today, the SonTek-IQ Pipe automatically determines if the pipe is full or partially full, and identifies the best technique to use to measure the velocity of the water. This information is then used to compute flow, along with accurate water level data provided by the vertical beam and/or pressure sensor. All this without additional configuration.

With a special form factor, the SonTek-IQ Pipe can provide accurate flow values in pipes from 0.5 all the way to 5.0 m, independent of whether these pipes are full or have only a few inches of water in them.

# SonTek-IQ ACCESSORIES AND SPECIFICATIONS

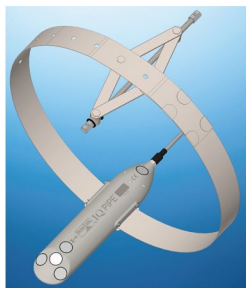

Custom-fit for the IQ Pipe, this easy to use mounting ring will make system installation a breeze. Fits pipe diameters from 16 in (41 cm) to 72 in (183 cm).

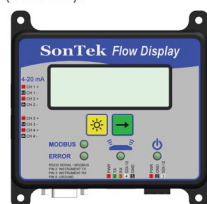

With the press of a single button, data is yours with the SonTek-IQ Flow Display. No PC required!

## Product Dimensions

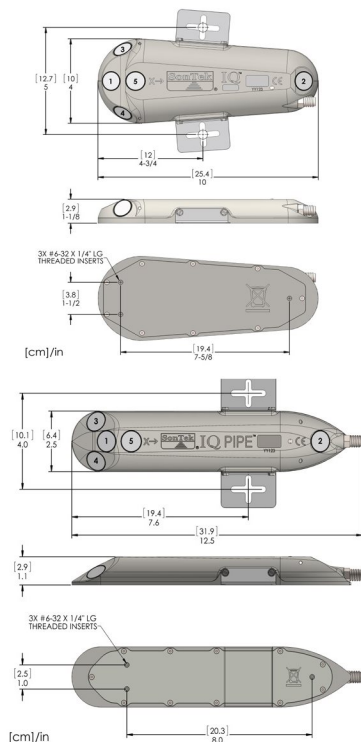

Specifications	SonTek-IQ Standard	SonTek-IQ Plus	SonTek-IQ Pipe
<u>Application</u>	Regular Canals	All Open Channels	Pipes & Culverts
<u>Velocity Measurement</u>			
-Sampling Range	0.05 - 1.5 m (0.16 - 5 ft)	0.05- 5.0 m (0.16 - 16 ft)	0.05 - 5.0 m (0.16 - 16 ft)
-Number of Cells	1	Up to 100	Up to 100
-Cell Size	Dynamically integrated	2 cm - 10 cm (0.8 - 4 in)	2 cm - 10 cm (0.8 - 4 in)
<u>Advanced Data Reprocessing</u>	N/A	✓	✓
<u>Increased Number of Data Fields</u>	N/A	✓	✓
<u>Velocity Measurement</u>			
-Velocity Range		±5 m/s (16 ft/s)	
-Resolution		0.0001 m/s (0.0003 ft/s)	
-Accuracy		±1% of measured velocity, ±0.5 cm/s (0.2 in/s)	
<u>Water Level</u>			
-Vertical Beam Range		0.05 - 1.5 m (0.2 - 5 ft) (Standard); 0.05 - 5.0 m (0.2 - 16 ft) (Plus/Pipe)	
-Water Level Accuracy		0.1% of measured depth or ±0.003 m (0.01 ft) whichever is greater	
-Pressure Sensor Range <sup>1</sup>		30 m (98 ft; 42 psi)	
-Pressure Sensor Accuracy		0.1% of full scale	
<u>Acoustics</u>			
-Acoustic Frequency		3.0 MHz	
-(2) Along Axis Beams		25° off vertical axis, along axis of channel	
-(2) Skew Beams		60° off vertical and 60° off center axis of channel (Standard/Plus); 37° off vertical and 45° off center axis of channel (Pipe)	
<u>Communications</u>		RS232, SDI-12, Modbus, Analog (via optional Flow Display)	
<u>Data Storage</u>		4 GB (approximately 1 year)	
<u>Operating/Storage Temperature</u>		-5 to 60° C (23 - 140° F)	
<u>Temperature Sensor</u>		Accuracy ± 0.2° C; Resolution ± 0.01° C	
<u>Tilt Sensor</u>		Accuracy ± 1.0°	
<u>SmartPulse<sup>HD</sup></u>		Yes	
<u>Power</u>			
-Input		9-15 VDC	
-Consumption		0.5 - 1.0 W (0.02 when idle)	

<sup>1</sup>For use in pressurized pipes. Housing rated to 42 psi.



Founded in 1992 and advancing environmental science globally, SonTek manufactures acoustic Doppler instrumentation for water velocity measurement in oceans, rivers, lakes, harbors, canals, estuaries, industrial pipes and laboratories. SonTek's sophisticated and proprietary technology serves as the foundation for some of the industry's most trusted flow data collection systems. SonTek is headquartered in San Diego, California, and is a brand of Xylem Inc.

SonTek  
9940 Summers Ridge Road  
San Diego CA 92121  
Tel +1.858.546.8327  
Fax +1.858.546.8150  
www.sontek.com

YSI, Inc.  
1700/1725 Brannum Lane  
Yellow Springs, Ohio 45387  
Tel +1.937.767.7241  
Fax +1.937.767.9353  
www.ysi.com

Xylem, Inc.  
1133 Westchester Avenue  
White Plains, NY 10604  
Tel +1.914.323.5700  
Fax +1.914.323.5800  
www.xylem.com

[www.sontek.com](http://www.sontek.com)

S16-01